

# Transformers

## Linear Power Transformers Quick Connector Low Volt. Linear Power Transformers

Detailed product specifications are available on: [us.100y.com.tw](http://us.100y.com.tw)



Part No.	Product No.	Description	Input Volt. (ACV)	Output Volt. (ACV)	Amp. (A)
39534	0-110-220V/0-12V/2A	Soldering Power Transformers	0-110-220V	0-3-4-5-6-9-12V	2A



Part No.	Product No.	Description	Input Volt. (ACV)	Output Volt. (ACV)	Amp. (A)
27007	110-220V/0-12-0-12/2A	Soldering Power Transformers	110-220VAC	0-12-0-12VAC	2A
33728	110-220V/0-18-24V/2A	Soldering Power Transformers	110-220VAC	0-18-24VAC	3A

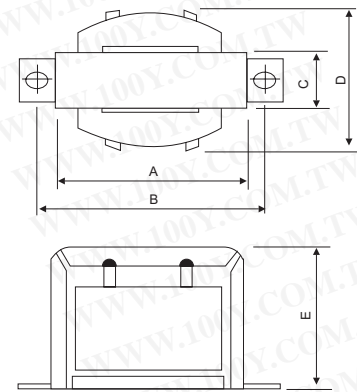

Product code	A	B	C	D	E
110-220V/12-0-12V/0.5A	42	53	16	33	35
110-220V/6V-0-6V/0.5A	42	53	16	33	35
110-220V/9-0-9V/0.5A	42	53	16	33	35
110V/12-0-12V/0.5A	42	53	16	33	35
110V/15-0-15/0.5A	42	53	16	33	35
110V/24-0-24V/0.5A	42	53	16	33	35
110V/6-0-6V/0.5A	42	53	16	33	35
110V/9-0-9V/0.5A	42	53	16	33	35
110-220V/12-0-12V/1A	58	69	21	38	50
110-220V/3-0-3V/1A	58	69	21	38	50
110-220V/9-0-9V/1A	58	69	21	38	50
110V/12-0-12V/1A	58	69	21	38	50
110V/15-0-15V/1A	58	69	21	38	50
110V/24-0-24V/1A	58	69	21	38	50
110V/28-0-28V/1A	58	69	21	38	50
110V/3-4-6-9-12V/1A	58	69	21	38	50
110V/36-0-36V/1A	58	69	21	38	50
110V/6-0-6V/1A	58	69	21	38	50
110V/7.5-0-7.5V/1A	58	69	21	38	50
110V/9-0-9V/1A	58	69	21	38	50

Product code	A	B	C	D	E
110V/12-0-12V/2A	60	81	28	48	57
110V/15-0-15V/2A	60	81	28	48	57
110V/24-0-24V/2A	60	81	28	48	57
110V/28-0-28V/2A	60	81	28	48	57
110V/36-0-36V/2A	60	81	28	48	57
110V/6-0-6V/2A	60	81	28	48	57
110V/12-0-12V/3A	77	91	30	53	66
110V/10-0-10V/3A	77	91	30	53	66
110V/24-0-24V/3A	77	91	30	53	66
110V/36-0-36V/3A	77	91	30	53	66
110V/40-0-40V/3A	77	91	30	53	66

Unit: mm

Part No.	Product No.	Description	Input Volt. (ACV)	Output Volt. (ACV)	Amp. (A)	VA
10508	110-220V/12-0-12V/0.5A	Soldering Power Transformers	110V-220VAC	12V-0V-12VAC	0.5A	
8357	110-220V/12-0-12V/1A	Soldering Power Transformers	110V/220VAC	12V-0V-12VAC	1A	
27000	110-220V/20-0-20V	Soldering Power Transformers	110-220VAC	20V-0V-20VAC		
17514	110-220V/24-0-24V/1A	Soldering Power Transformers	110-220VAC	24V-0V-24V	1A	
28051	110-220V/24V-0-24V/3A	Soldering Power Transformers	110-220VAC	24-0-24VAC	3A	
8359	110-220V/3-0-3V/1A	Soldering Power Transformers	110V/220VAC	3V-0V-3VAC	1A	
18434	110-220V/36-0-36V/2A	Soldering Power Transformers	110-220VAC	36V-0V-36VAC	2A	
8355	110-220V/9-0-9V/0.5A	Soldering Power Transformers	110V/220VAC	9V-0V-9VAC	0.5A	
8356	110-220V/9-0-9V/1A	Soldering Power Transformers	110VAC/220VAC	9V-0V-9VAC	1A	
15103	110V/10-0-10/2A	Soldering Power Transformers	110	10V-0-10V	2A	
14387	110V/10-0-10V/3A	Soldering Power Transformers	0-110V	10-0-10V	3A	
5695	110V/12-0-12V/0.5A	Soldering Power Transformers	0-110VAC	12-0-12VAC	0.5A	
5697	110V/12-0-12V/1A	Soldering Power Transformers	0-110V	12-0-12Vac	1A	
7666	110V/12-0-12V/2A	Soldering Power Transformers	0-110V	12V-0V-12VAC	2A	
17832	110V/12-0-12V/3.5A	Soldering Power Transformers	110VAC	12V-0V-12VAC	3.5A	
8271	110V/12-0-12V/3A	Soldering Power Transformers	110VAC	12V-0V-12VAC	3A	36W
7997	110V/15-0-15/0.5A	Soldering Power Transformers	0V-110V	15-0-15vac	0.5A	
5696	110V/15-0-15V/1A	Soldering Power Transformers	0-110V	15-0-15vac	1A	
10577	110V/15-0-15V/2A	Soldering Power Transformers	110VAC	15V-0V-15V	2A	
15952	110V/18V-0-18V/0.5A	Soldering Power Transformers	110VAC	18V-0V-18VAC	0.5A	
16081	110V/18V-0-18V/3A	Soldering Power Transformers	110VAC	18V-0V-18VAC	3A	
7996	110V/24-0-24V/0.5A	Soldering Power Transformers	0V-110V	24-0-24vac	0.5A	
10576	110V/24-0-24V/1A	Soldering Power Transformers	110V/24-0-24V/1A	24V-0V-24V	1A	
12244	110V/24-0-24V/2A	Soldering Power Transformers	0-110VAC	24V-0V-24VAC	2A	
8270	110V/24-0-24V/3A	Soldering Power Transformers	110VAC	24V-0V-24VAC	3A	
17066	110V/24-0-24V/4A	Soldering Power Transformers	0-110VAC	24V-0V-24VAC	4A	
5698	110V/28-0-28V/1A	Soldering Power Transformers	0-110VAC	28-0-28Vac	1A	
14286	110V/28-0-28V/2A	Soldering Power Transformers	0-110VAC	28-0-28Vac	2A	
12243	110V/36-0-36V/1A	Soldering Power Transformers	0-110VAC	36-0-36Vac	1A	
8634	110V/36-0-36V/2A	Soldering Power Transformers	110VAC	36V-0V-36VAC	2A	
8633	110V/36-0-36V/3A	Soldering Power Transformers	110VAC	36V-0V-36VAC	3A	



# Transformers

## Quick Connector Low Volt. Linear Power Transformers

Detailed product specifications are available on: [us.100y.com.tw](http://us.100y.com.tw)

Part No.	Product No.	Description	Input Volt. (ACV)	Output Volt. (ACV)	Amp. (A)
10578	110V/40-0-40V/3A	Soldering Power Transformers	110VAC	40V-0V-40V	3A
4723	110V/6-0-6V/0.5A	Soldering Power Transformers	0-110VAC	6-0-6VAC	0.5A
7999	110V/6-0-6V/1A	Soldering Power Transformers	0V-110V	6-0-6VAC	1A
12245	110V/6-0-6V/2A	Soldering Power Transformers	0-110VAC	6-0-6Vac	2A
8358	110V/7.5-0-7.5V/1A	Soldering Power Transformers	110VAC	7.5V-0V-7.5VAC	1A
42713	110V/700V 50W	Soldering Power Transformers	110~700V		71mA
7998	110V/9-0-9V/0.5A	Soldering Power Transformers	0V-110V	9-0-9Vac	0.5A
9250	110V/9-0-9V/1A	Soldering Power Transformers	0-110VAC	9V-0V-9VAC	1A
18035	AC110V/0-16V/2.5A	Soldering Power Transformers	110V	16V	2.5A



Product code	A	B	C	D	E
110V/6-0-6V/0.25A	29	38	11	25	26
110V/9-0-9V/0.25A	29	38	11	25	26
110V/12-0-12V/0.25A	29	38	11	25	26
110V/24-0-24V/0.25A	29	38	11	25	26
110V/3.3V/10A	60	81	28	48	57

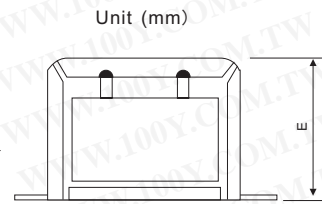
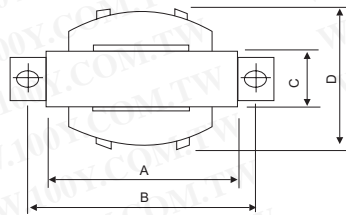

Part No.	Product No.	Description	Input Volt. (ACV)	Output Volt. (ACV)	Amp. (A)
37986	110V/12V/0.5A	Power Transformers	0-110Vac	12Vac	0.5A
8269	110V/24-0-24V/0.25A	Power Transformers	110VAC	24V-0V-24VAC	0.25A
14633	110V/3.3V/10A	Power Transformers	110V	3.3V	10A
4725	110V/9-0-9V/0.25A	Power Transformers	0-110Vac	9-0-9vac	0.25A
4724	EI28-110V/6-0-6V/0.25A	Power Transformers	0-110Vac	6-0-6Vac	0.25A



Part No.	Product No.	Description	Input Volt. (ACV)	Output Volt. (ACV)	Amp. (A)
36385	150V/12-0-12/1A	Soldering Power Transformers	150VAC	12-0-12VAC	1A



- Designed for 10/100 MB/s transmission over UTP-5 cable.
- Tested & qualified for use with national semiconductor's DP83840 Ethernet 10/100 PHY chip
- Cable interface for isolation and low common mode emissions.
- 16-PIN DIP package for economic cost
- Storage temperature range: -25°C to +125°C.
- Operating Temperature range: 0°C to +70°C.

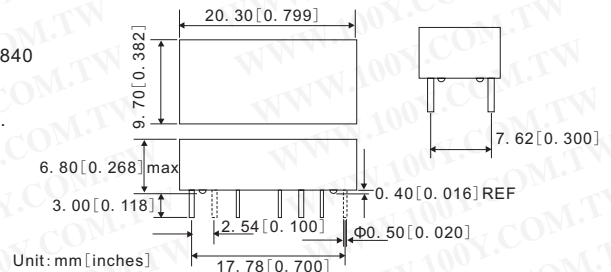

Part No.	Product No.	Description	Output Volt. (ACV)	Amp. (A)
39448	16PT8520	10/100 BASE-T TRANSFORMER	350V	8mA



Part No.	Product No.	Description	Input Volt. (ACV)	Output Volt. (ACV)	Amp. (A)
14688	220V/110V/2A	Soldering Power Transformers	220V	110V	2A



Part No.	Product No.	Description	Input Volt. (ACV)	Output Volt. (ACV)	Amp. (A)
30675	240V/700V/0.1A	Power Transformers	240Vac	700Vac	0.1A



Part No.	Product No.	Description	Input Volt. (ACV)	Output Volt. (ACV)	VA
39318	AC180V/12-0-12V	Soldering Power Transformers	0-180V	12-0-12Vac	500



# Transformers

## Quick Connector Low Volt. Linear Power Transformers

Detailed product specifications are available on: [us.100y.com.tw](http://us.100y.com.tw)



Part No.	Product No.	Description	Input Volt. (ACV)	Output Volt. (ACV)	Amp. (A)
36574	AC380V/220V/1A		380V(440V)	220V(110V)	1A
46477	AC380V/220V/3A		380V	220V	3A
23924	EI65*25	Soldering Power Transformers	220VAC	20V-15V-15VAC	

## PC Mount - Low Volt. Linear Power Transformers

Detailed product specifications are available on: [us.100y.com.tw](http://us.100y.com.tw)

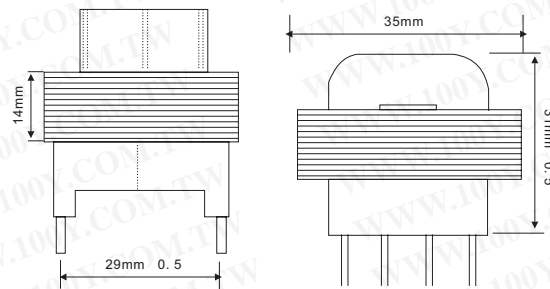
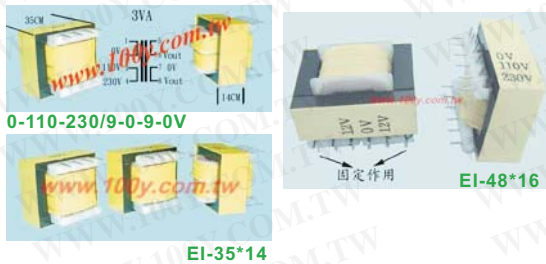

Part No.	Product No.	Description	Input Volt. (ACV)	Output Volt. (ACV)	Amp. (A)	Type	VA
44932	0-110-230V/9-0-9-0V	EI-35*14 PC Mount Power Transformers	0-110-230V	9-0-9-0V	0.17A*2	EI-35*14	3VA
28200	0-110-230V/12-0-12V	EI-35*14 PC Mount Power Transformers	0-110-230V	12-0-12V	0.32A*2	EI-48*16	7.5VA
18125	0-110-230V/12-0-12V	EI-35*14 PC Mount Power Transformers	0-110-230V	12-0-12V	0.13A*2	EI-35*14	3VA
28201	0-110-230V/15-0-15V	EI-48*16 PC Mount Power Transformers	0-110-230V	15-0-15V	0.24A*2	EI-48*16	7.5VA
18126	0-110-230V/15-0-15V	EI-35*14 PC Mount Power Transformers	0-110-230V	15-0-15V	0.10A*2	EI-35*14	3VA
28202	0-110-230V/18-0-18V	EI-48*16 PC Mount Power Transformers	0-110-230V	18-0-18V	0.21A*2	EI-48*16	7.5VA
18127	0-110-230V/18-0-18V	EI-35*14 PC Mount Power Transformers	0-110-230V	18-0-18V	0.08A*2	EI-35*14	3VA
18128	0-110-230V/24-0-24V	EI-35*14 PC Mount Power Transformers	0-110-230V	24-0-24V	0.06A*2	EI-35*14	3VA
18123	0-110-230V/4.5-0-4.5V	EI-35*14 PC Mount Power Transformers	0-110-230V	4.5-0-4.5V	0.33A*2	EI-35*14	3VA
28198	0-110-230V/6-0-6V	EI-35*14 PC Mount Power Transformers	0-110-230V	6-0-6V	0.63A*2	EI-48*16	7.5VA
28199	0-110-230V/9-0-9V	EI-35*14 PC Mount Power Transformers	0-110-230V	9-0-9V	0.42A*2	EI-48*16	7.5VA
18124	0-110-230V/9-0-9V	EI-35*14 PC Mount Power Transformers	0-110-230V	9-0-9V	0.17A*2	EI-35*14	3VA
18122	0-110V-230V/3.5-0-3.5V	EI-35*14 PC Mount Power Transformers	0-110-230V	3.5-0-3.5V	0.43A*2	EI-35*14	3VA

## Quick Connector High-Volt. Linear Power Transformers

Detailed product specifications are available on: [us.100y.com.tw](http://us.100y.com.tw)



Part No.	Product No.	Description	Input Volt. (ACV)	Output Volt. (ACV)	Amp. (A)	Type	VA
15951	208VAC/220VAC-15A-3	High Volt. Power Transformers	208-208-208VAC	220-220-220VAC	15A	3 Input 3 Output	660
14034	208VAC/220VAC-30A-3	High Volt. Power Transformers	208-208-208VAC	220-220-220VAC	30A	3 Input 3 Output	
27766	280VAC/220VAC-	High Volt. Power Transformers	208-208-208VAC	220-220-220VAC	16	1 Input 3 Output	3500



Part No.	Product No.	Input Volt. (ACV)	Output Volt. (ACV)	VA
23235	AC120V/AC400V 10mA			
27752	AC480V/AC100V-300VA	480V	100V	300VA



Part No.	Product No.	Description	Input Volt. (ACV)	Output Volt. (ACV)	Amp. (A)	Type
17493	220V/480V-5kVA	High Volt. Power Transformers	3 220V	3 480V	5kVA	3 Inputs 4 Outputs
17303	220V/480V-5kVA	High Volt. Power Transformers	3 220V	3 480V	5kVA	3 Input 3 Output



# Transformers

## Toroidal Transformers Open Lead-Style ac Primary

Detailed product specifications are available on: [us.100y.com.tw](http://us.100y.com.tw)



Part No.	Product No.	Description	Input Volt. (ACV)	Output Volt. (ACV)	Amp. (A)
42426	110V/6-0-15V/0.5A	Soldering Power Transformers	0-110VAC	6-0-15VAC	0.5A



Unit (mm)

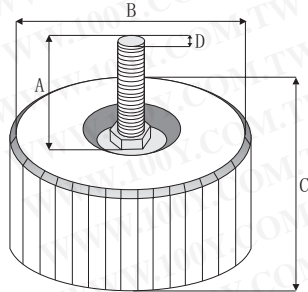

Product Code	A	B	C	D
Ring110/22-0-22/1.5A	20	65	30	5
Ring110/24-0-24/1.5A	20	65	30	5
Ring110/26-0-26/1.5A	20	65	30	5
Ring110/28-0-28/1.5A	20	65	30	5
Ring110/12Vx2/4A	22	65	40	5
Ring110/15Vx2/4A	22	65	40	5
Ring110/18Vx2/4A	22	65	40	5
Ring110/24Vx2/4A	22	65	40	5

Part No.	Product No.	Description	Input Volt. (ACV)	Output Volt. (ACV)	Amp. (A)	VA
13234	110/12V*2/4A	Open Lead-Style AC Primary Transformers	110VAC	12-0-12VAC	4A	
13235	110/15V*2/50W	Open Lead-Style AC Primary Transformers	110VAC	15-0-15VAC	4A	
13236	110/18V*2/50W	Open Lead-Style AC Primary Transformers	110VAC	18-0-18VAC	3A	50W
13149	110/22-0-22/1.5A	Open Lead-Style AC Primary Transformers	110VAC	44V	1.5A	66W
13150	110/24-0-24/1.5A	Open Lead-Style AC Primary Transformers	110V	48V	1.5A	72W
13237	110/24V*2/50W	Open Lead-Style AC Primary Transformers	110VAC	24-0-24VAC		50W
13151	110/26-0-26/1.5A	Open Lead-Style AC Primary Transformers	110V	52V	1.5A	78W
13152	110/28-0-28/1.5A	Open Lead-Style AC Primary Transformers	110V	56V	1.5A	84W
41751	110/6-0-15	Open Lead-Style AC Primary Transformers	0-220VAC	12-0-12VAC	500ma	
17595	110V/120V*2/12V	Open Lead-Style AC Primary Transformers	110V-0	0-120V*2 0-12V	1A/2A	
16886	110V/135V/12-0-12V	Open Lead-Style AC Primary Transformers	110V	135V 12-0-12V	0.1A/ 0.5A	
17596	110V/220V/120V/20V	Open Lead-Style AC Primary Transformers	110V-0	0-220V,0-120V,120-0-120V,0-20V	500mA/500mA/2A/8A	480VA
17594	110V/33V/16-0-16V	Open Lead-Style AC Primary Transformers	110V-0	0-33V*2 16-0-16V	20A/ 3A	
16533	110V/9V*2/18V*2	Open Lead-Style AC Primary Transformers	110V	9V/9V/18V/18V	9V(300mA) 18V(150mA)	
41319	220/12-0-12 50W	Open Lead-Style AC Primary Transformers	220VAC			50W

## Step-Up / Step-Down Transformers Step-Up / Step-Down Transformers

Detailed product specifications are available on: [us.100y.com.tw](http://us.100y.com.tw)



Part No.	Product No.	Description	Input Volt. (ACV)	Output Volt. (ACV)	Rating (KVA)	Size?	Weight
5747	2112-350W	Step-Up/Step-Down Transformers	110V-220V	110V-220V	350W	(L)155x(W)107x(H)80	2kg



Part No.	Product No.	Description	Input Volt. (ACV)	Output Volt. (ACV)	Rating (KVA)	Size	Weight
8695	AC100V/110V-1000W	Step-Up/Step-Down Transformers	110V	100V	1000W	(L)100x(W)85x(H)102	2.5kg
16811	AC100V/110V-2000W	Step-Up/Step-Down Transformers	100V	110V	2000W	(L)1145x(W)100x(H)120	4kg
8694	AC100V/110V-500W	Step-Up/Step-Down Transformers	110V	100V	500W	(L)100x(W)85x(H)102	2.2kg
49677	AC110V/100V-2000W	Step-Up/Step-Down Transformers	110V	100V	2000W		5.5kg
39655	AC110V/100V-2000W	Step-Up/Step-Down Transformers					
6806	AC110V/220V-1200W	Step-Up/Step-Down Transformers	110V	220V	1200W		8kg
9485	AC110V/220V-1500W	Step-Up/Step-Down Transformers	110VAC	220VAC	1500W		
32269	AC110V/220V-2000W	Step-Up/Step-Down Transformers	220VAC		2000W	(L)190x(W)115x(H)130	12kg
10145	AC110V/220V-2000W	Step-Up/Step-Down Transformers	110VAC	220VAC	2000W	(L)190x(W)115x(H)130	12kg
13952	AC110V/220V-200W	Step-Up/Step-Down Transformers	AV110V/220V	AC220V/110V	200W	(L)100x(W)85x(H)102	2.2kg
7667	AC110V/220V-2500W	Step-Up/Step-Down Transformers	110V	220V	2500W		
9486	AC110V/220V-3000W	Step-Up/Step-Down Transformers	110VAC	220VAC	3000W	(L)212x(W)115x(H)140	14kg
13953	AC110V/220V-300W	Step-Up/Step-Down Transformers	AC110V/220V	AC220V/110V	300W	(L)100x(W)85x(H)102	2.5kg
36552	AC110V/220V-500W	Step-Up/Step-Down Transformers	110VAC	220VAC	500W		
6804	AC110V/220V-600W	Step-Up/Step-Down Transformers	110V	220V	600W	(L)125x(W)95x(H)120	5.0kg
37109	AC110V/220V-750W	Step-Up/Step-Down Transformers	110Vac	220Vac	750W		
14434	AC120V/AC100V-200W	Step-Up/Step-Down Transformers	120Vac	100Vac	2000W		
15064	AC120V/AC100V/2000W	Step-Up/Step-Down Transformers	AC120V	AC100V	2000W		



# Transformers

## Step-Up / Step-Down Transformers

Detailed product specifications are available on: [us.100y.com.tw](http://us.100y.com.tw)



Part No.	Product No.	Description	Input Volt. (ACV)	Output Volt. (ACV)	Rating (KVA)	Size	Weight
16375	AC220V/110V-3000W	Step-Up/Step-Down Transformers	220V	110V	3000W	330(L)*180(W)*220(H)	15kg
39656	AC220V/200V-3000W	Step-Up/Step-Down Transformers	220V	200V	3000W		



Part No.	Product No.	Description	Input Volt. (ACV)	Output Volt. (ACV)	Rating (KVA)	Size	Weight
16085	DDC-220GC	Step-Up/Step-Down Transformers	22~28Vdc	13.8Vdc	15A	165(L)*120(W)*60(H)mm	1Kg



Part No.	Product No.	Description	Input Volt. (ACV)	Output Volt. (ACV)	Rating (KVA)	Size	Weight
21767	LD-500W	Step-Up/Step-Down Transformers	110V-220V	110V-220V	500W	(L)155x(W)107x(H)80	2kg



Part No.	Product No.	Description	Input Volt. (ACV)	Output Volt. (ACV)	Rating (KVA)	Size	Weight
11259	PT5A	Step-up/Step-Down Transformers	110V~120V	80V~130V	500W	5A	3kg



Part No.	Product No.	Description	Input Volt. (ACV)	Output Volt. (ACV)	Rating (KVA)	Size	Weight
6648	TC-200	Step-Up/Step-Down Transformers	AC110V/220V	AC220V/110V	200W	(L)103x(W)70x(H)80	1.8kg
6649	TC-300	Step-Up/Step-Down Transformers	110V/220V	AC220V/110V	300W	(L)105x(W)77x(H)90	2.2kg



Part No.	Product No.	Description	Input Volt. (ACV)	Output Volt. (ACV)	Rating (KVA)	Weight
50109	XB-1000VA	XB-1000VA Transformers	220v/50	110v/110	1KVA	3.5kg

## Audio Frequency Transformer Audio Transformers

Detailed product specifications are available on: [us.100y.com.tw](http://us.100y.com.tw)



Part No.	Product No.	Description	Impedance(Ohm)	Size	Weight
5147	P-192	Audio Transformers	1:1:1	(L)15x(W)20x(H)25	10g
6801	P-204	Audio Transformers	1:1	(L)15x(W)20x(H)27	10g
5143	P-212	Audio Transformers	1:1:1	(L)15x(W)20x(H)27	10g
5142	P-220	Audio Transformers	1:1:1	(L)15x(W)20x(H)27	10g
5047	ST-11	Audio Transformers	20K : 1K	(L)12x(W)15x(H)20	5g
5068	ST-17	Audio Transformers	25K:10K(CT)	(L)15x(W)20x(H)27	10g
5071	ST-20	Audio Transformers	10K:1K	(L)15x(W)20x(H)26	10g
5072	ST-21	Audio Transformers	10K:2K(CT)	(L)15x(W)20x(H)26	10g
5081	ST-22	Audio Transformers	8K:2K(CT)	(L)15x(W)20x(H)28	10g
5079	ST-23	Audio Transformers	2K:2K(CT)	(L)15x(W)20x(H)27	10g
5078	ST-24	Audio Transformers	1K:2K(CT)	(L)15x(W)20x(H)27	10g
5077	ST-25	Audio Transformers	4K:2K(CT)	(L)15x(W)20x(H)28	10g
5085	ST-26	Audio Transformers	20K:1K(CT)	(L)15x(W)20x(H)27	10g
5096	ST-27	Audio Transformers	20K:2K(CT)	(L)15x(W)20x(H)28	10g
5095	ST-28	Audio Transformers	20K:4K(CT)	(L)15x(W)20x(H)28	10g
5097	ST-29	Audio Transformers	25K:5K(CT)	(L)15x(W)20x(H)27	10g
5105	ST-30	Audio Transformers	0.125K:30K	(L)15x(W)20x(H)28	10g
5102	ST-31	Audio Transformers	500(CT):3.2	(L)15x(W)20x(H)27	10g
5103	ST-32	Audio Transformers	1.2(CT):8	(L)15x(W)20x(H)28	10g
5145	ST-401	Audio Transformers	600(CT):600:8	(L)12x(W)15x(H)20	5g
5098	ST-42	Audio Transformers	300(CT):0.48	(L)23x(W)28x(H)38	70g
5109	ST-45	Audio Transformers	600(CT):10	(L)15x(W)20x(H)28	10g
5106	ST-46	Audio Transformers	400(CT):0.48	(L)25x(W)30x(H)38	70g
5107	ST-47	Audio Transformers	500(CT):0.48	(L)23x(W)30x(H)38	70g
5104	ST-48	Audio Transformers	600(CT):0.48	(L)25x(W)30x(H)38	70g
5112	ST-52	Audio Transformers	600(CT):2K	(L)15x(W)20x(H)28	10g
5117	ST-53	Audio Transformers	750:350(CT)	(L)23x(W)30x(H)38	70g
5113	ST-71	Audio Transformer	600:600(CT)	(L)15x(W)20x(H)27	10g
5110	ST-72	Audio Transformers	600:1K(CT)	(L)15x(W)20x(H)27	10g



# Transformers

## Audio Transformers

Detailed product specifications are available on: [us.100y.com.tw](http://us.100y.com.tw)



Part No.	Product No.	Description	Impedance(Ohm)	Size	Weight
5121	ST-73	Audio Transformers	1K:1K(CT)	(L)15x(W)20x(H)27	10g
5120	ST-74	Audio Transformers	6K:3K(CT)	(L)15x(W)20x(H)27	10g
5111	ST-75	Audio Transformers	10K:600(CT)	(L)15x(W)20x(H)27	10g
5115	ST-76	Audio Transformers	3K:1.2K(CT)	(L)15x(W)20x(H)27	10g
5129	ST-77	Audio Transformers	10K:3K(CT)	(L)15x(W)20x(H)27	10g
5131	ST-78	Audio Transformers	10K:10K(CT)	(L)15x(W)20x(H)27	10g
5125	ST-79	Audio Transformers	600(CT):40(CT)	(L)25x(W)30x(H)38	70g
5122	ST-81	Audio Transformers	1K(CT):8	(L)15x(W)20x(H)27	10g
5137	ST-82	Audio Transformers	500(CT):8	(L)15x(W)20x(H)27	10g
5136	ST-83	Audio Transformers	400(CT):8	(L)15x(W)20x(H)27	10g
5132	ST-91	Audio Transformers	900:100CT		
5133	ST-92	Audio Transformers	1.3K:150(CT)		

## Variable Auto-Transformers Variable AC Transformers

Detailed product specifications are available on: [us.100y.com.tw](http://us.100y.com.tw)



Part No.	Product No.	Description	ACVin	ACVout	W(AV)	Amp.(A)	Weight
14689	0-130V/2.5A	Manual-Variable AC Transformers	110V	0-110/130V	325W	2.5A	2kg
13677	0-130V/3A	Manual-Variable AC Transformers	110V	0-110/130V	390W	3A	



0V-140V/5A-110V



0V-260V/10A-110/220V



0V-260V/1A-220V



0V-260V/5A-110V/220V

Part No.	Product No.	Description	ACVin	ACVout	W(AV)	Amp.(A)	Weight	High	Outside Size
8606	0V-140V/5A-110V	Manual-Variable AC Transformers	110V	0~140V	5A	5A	3.6kg	120mm	116mm
9254	0V-260V/10A-110/220V	Manual-Variable AC Transformers	110/220VAC	0~260VAC		10A	12kg	160mm	255mm
30676	0V-260V/1A-220V	Manual-Variable AC Transformer	220V	0V-260V		1A		60mm	70mm
8609	0V-260V/5A-110V/220V	Manual-Variable AC Transformers	110V/220V	0~260V		5A	7.2kg	150mm	165mm



Part No.	Product No.	Description	ACVin	ACVout	W(AV)
32190	AC220V/110V-2KW	Variable AC Transformers	220V	110V	
33080	AC480V/110V-600W	Variable AC Transformers	480V	110	600W



Part No.	Product No.	Description	ACVin	ACVout	W(AV)	Weight
8612	LD-66500	Manual-Variable AC Transformers	110V/220V	0~260V	500W	4kg



Part No.	Product No.
41259	0~140V/20A-110V

- We provide a wide range of products to development and maintenance engineers in all type of business
- If you cannot find the components you want on the catalogue, please call us.

Taiwan: 886-3-5753170

Shanghai: 021-54151736 Shenzhen: 0755-83298787

### Centenary Materials

Waiting for your phone call



T E L : Taiwan: 886-3-5753170  
F A X : Taiwan: 886-3-5753172  
E-mail: Taiwan: [us\\_sale@100y.com.tw](mailto:us_sale@100y.com.tw)

Shenzhen: 86-755-83298787  
Shenzhen: 86-755-83640655  
Shenzhen: [100y@163.com](mailto:100y@163.com)

Shanghai: 86-21-54151736  
Shanghai: 86-21-64605107  
Shanghai: [100y-1@163.com](mailto:100y-1@163.com)

# Transformers

## Variable AC Transformers

Detailed product specifications are available on: [us.100y.com.tw](http://us.100y.com.tw)

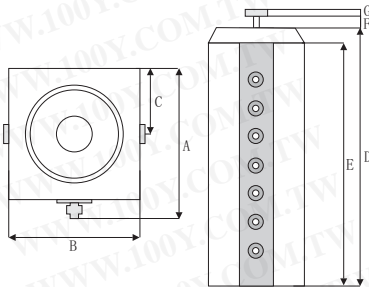

	S3P-240-5	S3P-240-20
A	142.3	A 232.3
B	140	B 230
C	70	C 115
D	365	D 480
E	355	E 460
F	8	F 8
G	25	G 35

- It is same concept as transformer. So output distortion fluctuation is small
- It is a voltage adjuster capable of changing continuously output voltage from 0 to a desired level
- High efficiency

Part No.	Product No.	Description	ACVin	ACVout	Amp.(A)	Weight	High	Outside Size
15119	S3P-240-20	3 Phase AC Transformers	0~220V	0~240V	20A	39kg	480	230*230
15120	S3P-240-5	3 Phase AC Transformers	0~220V	0~240V	5A	14kg	365	140*140



VAT-1000

VAT-2000

Part No.	Product No.	Manufacturer	Description	ACVin	W(AV)
20571	VAT-1000	GOLDTOOL	Step-Up/Step-Down Transformers	110/240VAC	1000VA
20572	VAT-2000	GOLDTOOL	Step-Up/Step-Down Transformers	110/240VAC	2000VA

## AC Power A. V. R AVR Auto-Variable-Regulator

Detailed product specifications are available on: [us.100y.com.tw](http://us.100y.com.tw)



- Reaction time: 0.1 Sec
- Efficiency: more than 98%
- Working environmental temperature: 0°C~+40°C
- Humidity: 95%

Part No.	Product No.	Description	Vin (Vac)	Vout (Vac)	Rated VA (W)	Size	Weight
17192	110V/100V-2KVA	AVR Auto-Variable-Regulator	110V	100V	2KVA	370*205*203mm	17KG



### Technical specifications

Power supply, type	10A
Order number	6EP1 334-2BA00
Input	Single-phase AC
Rated voltage Vin rated	120/230V AC selected by wire jumper
Voltage range	85 to 132 V/187 to 264 V AC
Surge strength	2.3xV <sub>in rated</sub> , 1.3ms (EN 61 000-4-1)
Output	Regulated, floating direct voltage
Rated voltage V <sub>out rated</sub>	24VDC

Operating specifications	
Ambient temperature range	0 to +60°C with natural convection
Humidity class	Climate class 3K3 to EN 60 721

Part No.	Product No.	Manufacturer	Description	Vout (Vac)
39150	6EP1334-2BA00	SIEMENS	AVR Auto-Variable-Regulator	24VDC



Part No.	Product No.	Description	Vin (Vac)	Vout (Vac)	Rated VA (W)
50316	AVR-1.2KR	Automatic Voltage Regulation	Capacity:1200VA	110Vac	110Vac
50318	AVR-2KR	Automatic Voltage Regulation	Capacity:2000VA	110Vac	110Vac
50323	AVR-3KR	Automatic Voltage Regulation	Capacity:3000VA	110Vac	110Vac
50324	AVR-5KR	Automatic Voltage Regulation	Capacity:5000VA	110Vac	110Vac



Part No.	Product No.	Description	Vin (Vac)	Vout (Vac)	Rated VA (W)	Size	Weight
11128	AVR-2000W	AVR Auto-Variable-Regulator	60-130V/140-240VAC	110/110VAC	2000W	(L)275x(W)213x(H)200	12kg

- We provide a wide range of products to development and maintenance engineers in all type of business
- If you cannot find the components you want on the catalogue, please call us.

Taiwan: 886-3-5753170  
Shanghai: 021-54151736 Shenzhen: 0755-83298787

**Centenary Materials**  
Waiting for your phone call



T E L : Taiwan: 886-3-5753170  
F A X : Taiwan: 886-3-5753172  
E-mail: Taiwan: [us\\_sale@100y.com.tw](mailto:us_sale@100y.com.tw)

Shenzhen: 86-755-83298787  
Shenzhen: 86-755-83640655  
Shenzhen: [100y@163.com](mailto:100y@163.com)

Shanghai: 86-21-54151736  
Shanghai: 86-21-64605107  
Shanghai: [100y-1@163.com](mailto:100y-1@163.com)

# Transformers

## AVR Auto-Variable-Regulator

Detailed product specifications are available on: [us.100y.com.tw](http://us.100y.com.tw)



Capacity	220Volts, 1000Watts
Guaranteed Output	220Vac
Accuracy	+/-10%
Input Voltage Range	175 to 270 Vac
Power-on-delay time	4 to 6 minutes
Response time	100ms
Number of Outlets	4 x 220V

Part No.	Product No.	Description	Vin (Vac)	Vout (Vac)	Rated VA (W)	Size	Weight
6187	AVR1000W	AVR Auto-Variable-Regulator	50-130V/160-240Vac	110V/220Vac	1000W	(L)183x(W)213x(H)138	6kg
17506	AVR500W	AVR Auto-Variable-Regulator	50-130/160-240V	110/220V ± 2%	500W	(L)180x(W)190x(H)127	5kg
7575	AVR500W	AVR Auto-Variable-Regulator	50-130/160-240V	110/220V	500W	(L)180x(W)190x(H)127	5kg



Part No.	Product No.	Description	Vin (Vac)	Vout (Vac)	Rated VA (W)	Size	Weight
5749	AVR650W-R	AVR Auto-Variable-Regulator	80-130VAC	110VAC	650W	(L)190x(W)210x(H)145	5kg



### Features:

- MICRO SIZE
- SURGE PROTECTION
- COMPACT AND RELIABLE
- HIGH EFFICIENCY 97% ~ 99%
- HIGH POWER FACTOR 0.98 ~ 1
- OVER LOAD / SHORT PROTECTION

### Applications :

- PERSONAL COMPUTER
- LASER PRINTER
- CASH REGISTER
- ATM
- OA EQUIPMENT
- HOUSEHOLD ELECTRICAL APPLIANCES
- PRODUCTION LINE
- INSTRUMENT
- COPY / PRINTING DEVICE
- POS TERMINAL
- ALARM / SECURITY SYSTEM

Part No.	Product No.	Description	Vin (Vac)	Vout (Vac)	Rated VA (W)	Size	Weight
5492	ND-1000	AVR Auto-Variable-Regulator	110VAC	110VAC	1000W	(L)205x(W)103x(H)78	2kg
5493	ND-500	AVR Auto-Variable-Regulator	110VAC	110VAC	500W	(L)205x(W)103x(H)78	2kg

## Isolation Transformers

Detailed product specifications are available on: [us.100y.com.tw](http://us.100y.com.tw)



Part No.	Product No.	Description	Primary Volt. (ACV)	Secondary Volt. ACV	Weight(g)
28653	110V/298V*2	Isolation Transformers	110AC	298VAC	1kg



Part No.	Product No.	Description	Primary Volt. (ACV)	Secondary Volt. ACV	Size(mm)	Weight(g)	Shape
20073	AC110-115V/150V-15V	Isolation Transformers	150V*2/0.1A 15V*2/0.5A	110V-115V	78*88*67	1580g	Soldering



AC110V/220V-220V/5KW

Part No.	Product No.	Description	Primary Volt. (ACV)	Secondary Volt. ACV	Rating Watts (VA)	Size(mm)	Weight(g)	Shape
12297	AC110-220Vin/AC110-220Vout/2KW	Isolation Transformers	AC110-220Vin	AC110-220Vout	2KW	(L)192x(W)170x(H)150	18.5kg	Bakelite
31901	AC110V/100V-110-220V/300W	Isolation Transformers	110VAC	100-110-220VAC	300W	115x100x100	5.5kg	Bakelite
37725	AC110V/220V-220V/5KW	Isolation Transformers	AC110V	AC220V	5KW			
10371	AC110V/24V-0-24V/50W	Isolation Transformers	110VAC	24-0-24VAC	50W			Bakelite



Part No.	Product No.	Description	Primary Volt. (ACV)	Secondary Volt. ACV
37110	AC110V/5V*2	Isolation Transformers	110AC	5V





# Transformers

## Isolation Transformers

Detailed product specifications are available on: [us.100y.com.tw](http://us.100y.com.tw)



AC110V/AC220V/300W

Part No.	Product No.	Description	Primary Volt. (ACV)	Secondary Volt. ACV	Rating Watts (VA)	Size(mm)	Weight(g)	Shape
20599	AC110V/AC100/2KW	Isolation Transformers	AC110	AC100	2KW	(L)192x(W)170x(H)150	18.5kg	Red
50630	AC110V/AC110V-3000W	Isolation Transformers	110	110	3000W	190*175*160		Bakelite
10367	AC110V/AC110V/1000W	Isolation Transformers	110VAC	110VAC	1000W	(L)170x(W)132x(H)150	12kg	Bakelite
41757	AC110V/AC110V/1000W	Isolation Transformers	110VAC	110VAC	1000W	(L)170x(W)132x(H)150	12kg	Bakelite
10365	AC110V/AC110V/100W	Isolation Transformers	AC110V	AC110V	100W	(L)100x(W)75x(H)90	2kg	
10368	AC110V/AC110V/500W	Isolation Transformers	110VAC	110VAC	500W	(L)130x(W)135x(H)115	8kg	
41040	AC110V/AC220V/300W	Isolation Transformers	110AC	AC110V-220V				
10369	AC110V/AC220V/500W	Isolation Transformers	110VAC	220VAC	500W	(L)150x(W)132x(H)118	10kg	Bakelite



Part No.	Product No.	Description	Primary Volt. (ACV)	Secondary Volt. ACV	Rating Watts (VA)	Size(mm)	Weight(g)	Shape
19736	AC110Vin/AC140Vout/56W	Isolation Transformers	140VAC	110VAC	56W	77*42*67	1700g	Soldering



Part No.	Product No.	Description	Primary Volt. (ACV)	Secondary Volt. ACV	Rating Watts (VA)	Size(mm)	Weight(g)	Shape
49678	AC220V/50V-250W5A	Isolation Transformers	220	50	250W(5A)	12*11.5*9.5	4.5g	Bakelite



Part No.	Product No.	Description	Primary Volt. (ACV)	Secondary Volt. ACV	Rating Watts (VA)	Size(mm)	Weight(g)	Shape
43109	AC220V/AC220V-1000W	Isolation Transformers	220V	220V	1000W			
16977	AC220V/AC220V-100W	Isolation Transformers	220V	220V		105*75*88		
12411	AC220Vin/AC110Vout/330W	Isolation Transformers	220	110	330W(3A)			Bakelite
15656	AC380V/AC110V/220V-1000W	Isolation Transformers	380V	100V/220V	1000VA	(L)173*(W)133*(H)134mm	10.2Kg	Bakelite
17833	AC380V/AC220V-3A	Isolation Transformers	380V	220V	3A	(L)120*(W)115*(H)123mm	4-5Kg	Bakelite

## RF Transformers

Detailed product specifications are available on: [us.100y.com.tw](http://us.100y.com.tw)



### Features

- excellent return loss, 26 dB typ. in 1 dB bandwidth
- excellent amplitude unbalance, 0.4 dB typ. and phase unbalance, 3 deg. typ. in 1 dB badwidth
- excellent insertion loss flatness, ±0.25 dB

### Applications

- impedance matching
- balanced amplifiers

Part No.	Product No.	Manufacturer	Description	Impedance(Ohm)	Case Style
36939	JTX-2-10T+	Mini-Circuits	Mini-Circuits_RF XFMR/SURF MOUNT/T&R/ROHS	2 ohm	BH292

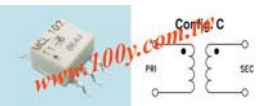

### Features

- good return loss
- also available with plug-in (X65) and flat-pack (W38) leads

### Applications

- HF/VHF
- receivers/transmitters

A1-6

### Features

- wideband, 0.02 to 200 Mhz
- excellent return loss
- also available with plug-in (X65) and flat-pack (W38) leads

### Applications

- HF/VHF
- impedance matching
- receivers/transmitters

A4-6

Part No.	Product No.	Manufacturer	Description	Impedance(Ohm)	Case Style
47023	T1-6-KK81	Mini-Circuits	Mini-Circuits_RF XFMR/SURF MOUNT(ROHS)	50 ohm	KK81
47022	T4-6-KK81	Mini-Circuits	Mini-Circuits_RF XFMR/SURF MOUNT(ROHS)	50 ohm	KK81



Part No.	Product No.	Manufacturer	Description	Impedance(Ohm)	Case Style
24646	TMO-1-1T	Mini-Circuits	Mini-Circuits_RF XFMR	1 ohm	A11

