

# Switches & Control Gear

## Toggle Switch

Detailed product specifications are available on: [us.100y.com.tw](http://us.100y.com.tw)



MT-1131-3P2

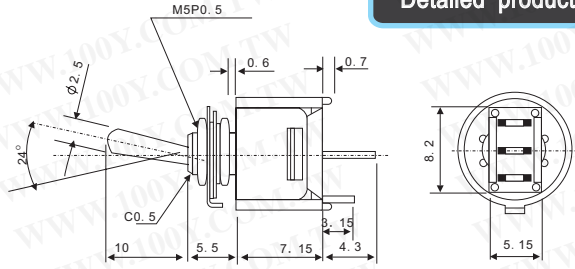

Unit: mm

Part No.	Product No.	Description	No. of Pos.	Volt./Current	Type
4233	MT-1131-3P2	Toggle Switch	3P2	3A/125Vac	ON-ON



MT-1131P-3P2



MT1061-P-6P2

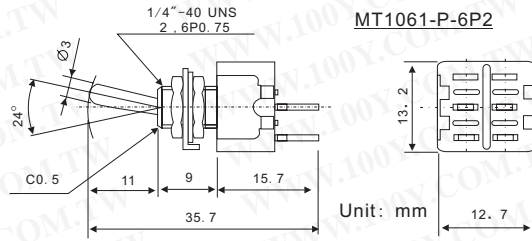

Unit: mm

Part No.	Product No.	Description	No. of Pos.	Volt./Current	Type
28301	MT-1131P-3P2	Toggle Switch	3P2	1.5A/250Vac	ON-ON
16641	MT1061-P-6P2	Toggle Switch	6P2	125Vac/6A	ON-OFF

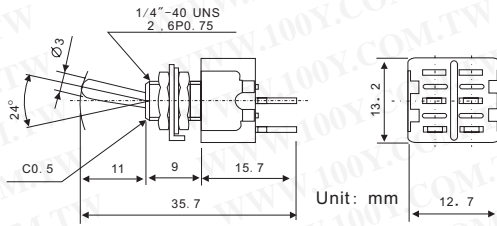

Unit: mm

Part No.	Product No.	Description	No. of Pos.	Volt./Current	Type
7738	NT1061-6P2	Toggle Switch	6P2	125Vac/6A	ON-OFF



TERMINAL

0 5 10 S0

<b>Rating</b> 6A 125V AC 3A 250V AC
<b>Contact resistance</b> 50o ohm Max
<b>Insulation resistance</b> DC 500V 100o ohm Min
<b>Dielectric strength</b> AC 1500V 1 minute
<b>Cut-out</b> 

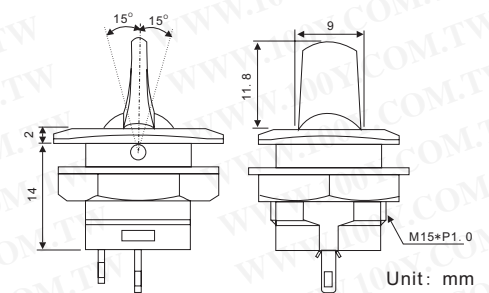
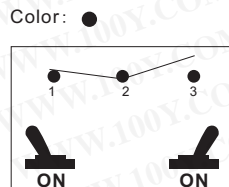

Unit: mm

**FEATURES:**

- Material: frames are nylon (UL flame: 94V-2). Terminals are silver plated brass
- Pins/Terminal type: 3P SPDT

Part No.	Product No.	Description	No. of Pos.	Volt./Current	Color	Type
14138	R13-402C-05	Toggle Switch	3P SPDT	6A125VAC/3A250VAC	All Black	SPDT ON-ON



TERMINAL

0 5 10 S0

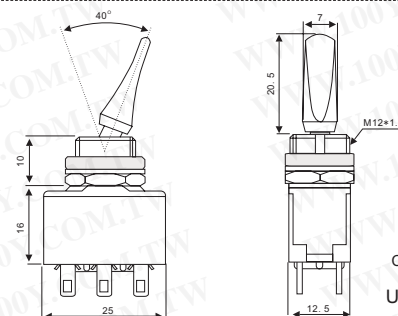
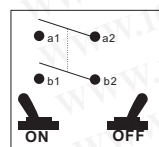

Unit: mm

<b>Rating</b> 6A 125V AC 3A 250V AC
<b>Contact resistance</b> 50o ohm Max
<b>Insulation resistance</b> DC 500V 100o ohm Min
<b>Dielectric strength</b> AC 1500V 1 minute
<b>Cut-out</b> 

Part No.	Product No.	Description	No. of Pos.	Volt./Current	Color	Type
14282	R13-406F2-05	Toggle Switch	4P/S0 Solder	6A/125V 3A/250V	Metalized/Black	DPST ON-OFF



T E L : Taiwan: 886-3-5753170  
F A X : Taiwan: 886-3-5753172  
E-mail : Taiwan: [us\\_sale@100y.com.tw](mailto:us_sale@100y.com.tw)

Shenzhen: 86-755-83298787  
Shenzhen: 86-755-83640655  
Shenzhen: [100y@163.com](mailto:100y@163.com)

Shanghai: 86-21-54151736  
Shanghai: 86-21-64605107  
Shanghai: [100y-1@163.com](mailto:100y-1@163.com)