

# Semiconductors-Discretes

## Ultrafast Recovery Diodes

Detailed product specifications are available on: [us.100y.com.tw](http://us.100y.com.tw)

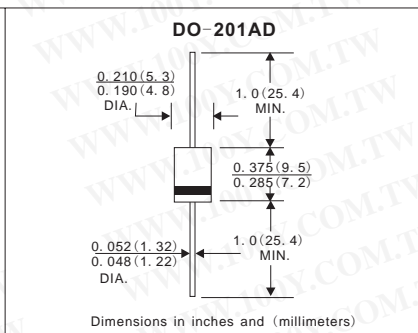
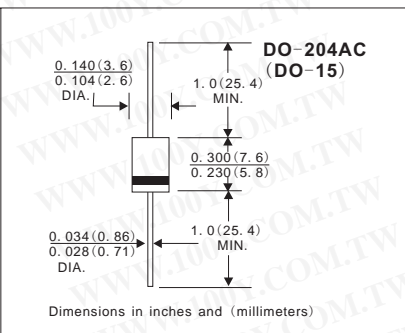
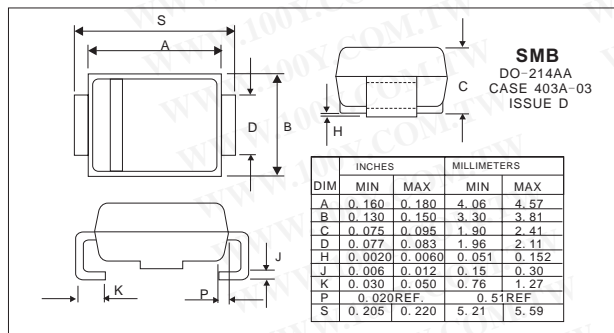
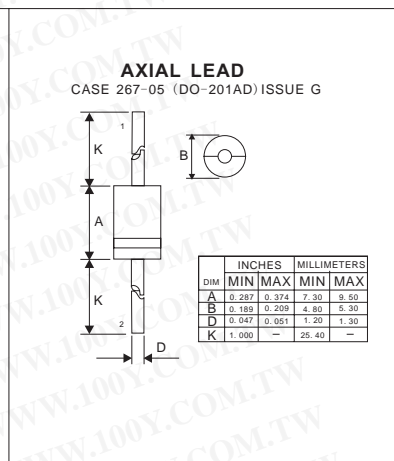
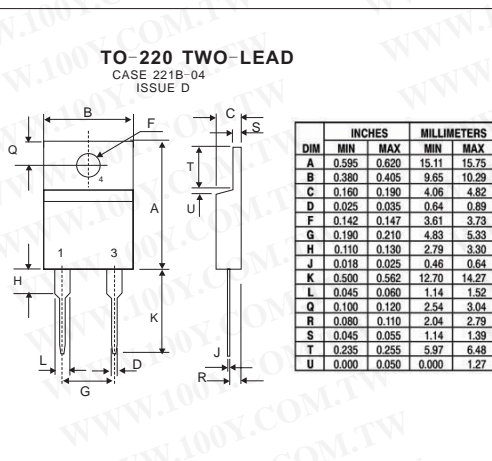
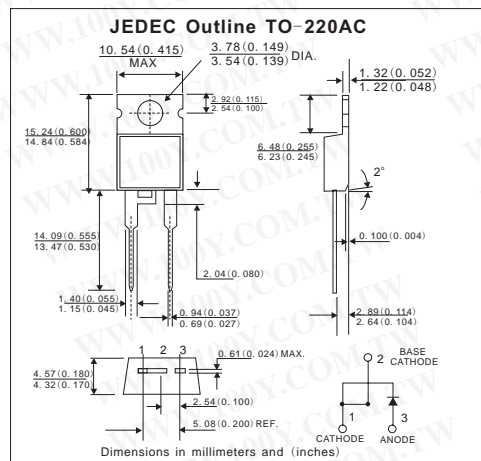
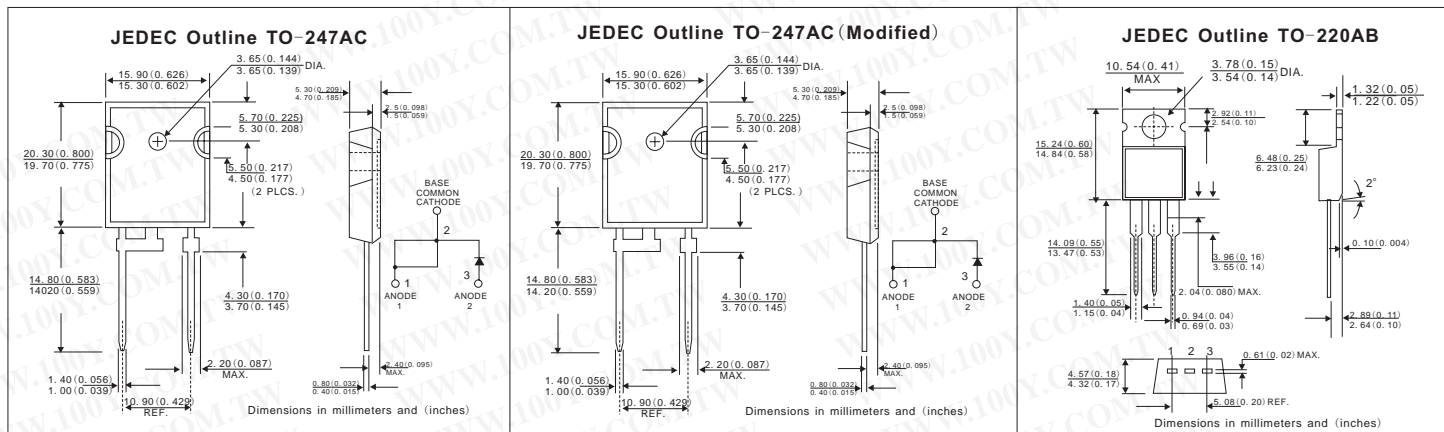

Part No.	Product No.	Manufacturer	Description	Pins/Package	Vrrm	IF (A)	Trr (nS)	Marking/
33475	HFA16PA60C	IR	Ultrafast, Soft Recovery Diode	TO-247AC	600V	8.0A	18ns	
33476	HFA16PB120	IR	Ultrafast, Soft Recovery Diode HEXFRED	TO-247AC (Modified)	1200V	16A	30ns	
33477	HFA16TA60C	IR	Ultrafast, Soft Recovery Diode	TO-220AB	600V	8.0A	18ns	
33479	HFA16TB120	IR	Ultrafast, Soft Recovery Diode	TO-220AC	1200V	16A	30ns	
33480	HFA25PB60	IR	Ultrafast, Soft Recovery Diode	TO-247AC (Modified)	600V	25A	23ns	
33483	HFA30PA60C	IR	Ultrafast Soft Recovery Diode	TO-247AC	600V	15A	19ns	
45008	HFA30PA60CPBF	IR	Ultrafast Soft Recovery Diode	TO-247AC	600V	15A	19ns	
33486	HFA30PB120	IR	Ultrafast, Soft Recovery Diode	TO-247AC (Modified)	1200V	30A	47ns	
33484	HFA30TA60C	IR	Ultrafast, Soft Recovery Diode	TO-220AB	600V	15A	19ns	
33485	HFA50PA60C	IR	Ultrafast, Soft Recovery Diode	TO-247AC	600V	25A	23ns	
31937	MUR1560CT	ON-Semi.	Ultrafast Rectifier	2P/TO-220	600V	15A	60nS	
23602	MUR4100E	ON-Semi.	ON_Ultrafast Recovery Diodes	DO-41	1000V	4A	100nS	MUR4100E
35507	MURS160T3	ON-Semi.	Surface Mount Ultrafast Power Rectifier	SMB	600V	1.0A	75ns	
28985	RHRP1560		15A, 400V - 600V Hyperfast Diode	TO-220AC	600V			
28310	RURP860	Fairchild	Ultrafast Diodes Switchmode	2P/TO-220	600V	8A	60ns	
14531	RURP860	Intersil	Ultrafast Diodes Switchmode	2P/TO-220AC	600V	8A	60ns	
34821	SBYV27-100	VISHAY	Soft Recovery Ultrafast Plastic Rectifier	DO-204AC	100V	2A	15ns	
34822	SBYV27-150	VISHAY	Soft Recovery Ultrafast Plastic Rectifier	DO-204AC	150V	2A	15ns	

