

# Resistors & Potentiometers

## Piher\_Single-Turn Potentiometer

Detailed product specifications are available on: [us.100y.com.tw](http://us.100y.com.tw)



### HORIZONTAL MOUNT - VERTICAL ADJUST

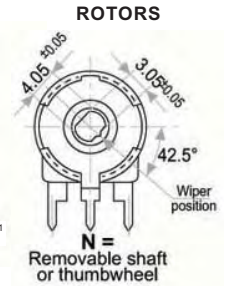
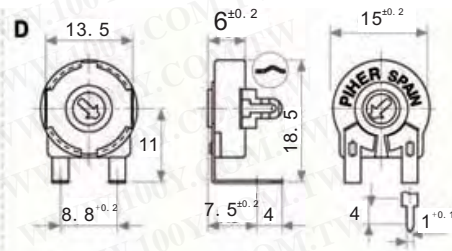
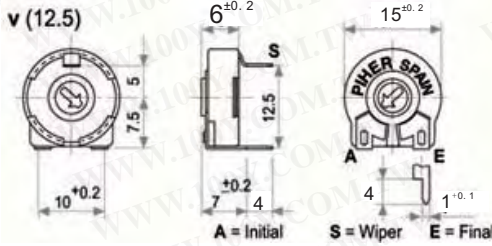

### VERTICAL MOUNT - HORIZONTAL ADJUST

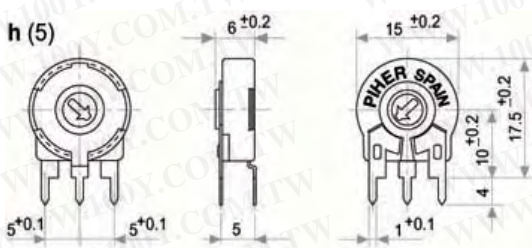

### HORIZONTAL MOUNT - VERTICAL ADJUST

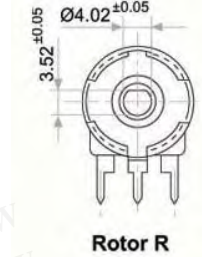
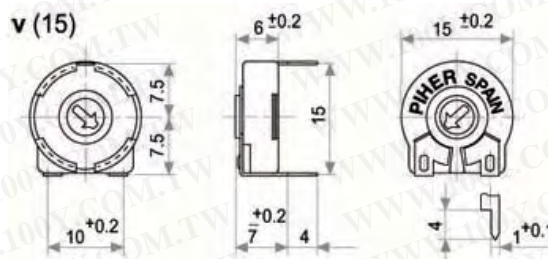

Part No.	Product No.	Manufacturer	Description	Resistance data(Ω)	Tolerance(±)	Shaft Dia. (mm)
41268	PT15NH05-104A1010-E	PIHER	5mm Carbon Potentiometer NH05-104A	100KΩ	±20%	5mm
41269	PT15NV15-503A2020	PIHER	5mm Carbon Potentiometer NV15-503A	50KΩ	±20%	5mm
41270	PT15NV18-103A2020	PIHER	5mm Carbon Potentiometer NV18-103A	10KΩ	±20%	5mm
41273	PT15RV02-472A2020-E	PIHER	5mm Carbon Potentiometer RV02-472A	4.7KΩ	±20%	5mm



### FEATURES

- Carbon resistance element
- Dust proof enclosure
- Polyester substrate
- Also upon request:
  - Wiper positioned at 50% or fully clockwise
  - Supplied in magazines for automatic insertion
  - Long life model PT-6...E (10,000cycles)
  - Without crimping model. PT-6...SC
  - Housing available in self extinguishable plastic (VL94V0)

### MECHANICAL SPECIFICATIONS

Mechanical rotation angle	235° ± 5°
Electrical rotation angle	200° ± 20°
Torque	0.2 to 2 Ncm. (0.3 to 2.7 in-oz)
Stop torque	>4 Ncm. (>5.6 in-oz)

### ELECTRICAL SPECIFICATIONS

Range of values (*)	220Ω ≤ Rn ≤ 5M (Decad, 1.0-2.0-2.2-2.5-4.7-5.0)
Tolerance (*)	220Ω ≤ Rn ≤ 1MΩ ±20% 1MΩ < Rn ≤ 5MΩ ±30%
Max. voltage	100VDC (lin) 50VDC (no lin)
Residual resistance	≤5, 10 <sup>-3</sup> Rn (2Ω min.)
Equivalent noise resistance	≤3% Rn (3Ω min.)
Operating temperature	-25°C + 70°C (-13°F + 158°F)

### ROTORS

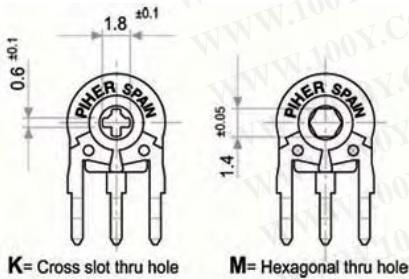

### MOUNTING METHODS. VARIATIONS

V=Horizontal mount / Vertical adjust

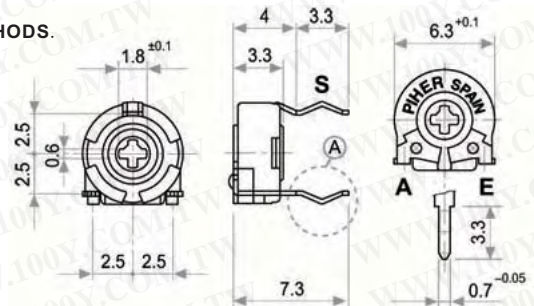

Part No.	Product No.	Manufacturer	Description	Resistance data(Ω)	Tolerance(±)	Shaft Dia. (mm)
41328	PT6KV-102A2020	PIHER	Carbon Potentiometer PT6KV-102A	1KΩ	±20%	
41329	PT6KV-104A2020	PIHER	Carbon Potentiometer PT6KV-104A	100KΩ	±20%	
41330	PT6KV-104B2020-RO	PIHER	Carbon Potentiometer PT6KV-104B	100KΩ	±20%	
41332	PT6KV-105A2020	PIHER	Carbon Potentiometer PT6KV-105A	1MΩ	±20%	
41333	PT6KV-203B2020	PIHER	Carbon Potentiometer PT6KV-203B	20KΩ	±20%	
41334	PT6KV-204A2020	PIHER	Carbon Potentiometer PT6KV-204A	200KΩ	±20%	2.5mm*2.5
41335	PT6KV-205A3030	PIHER	Carbon Potentiometer PT6KV-205A	2MKΩ	±30%	2.5mm*2.5
41337	PT6KV-254A2020	PIHER	Carbon Potentiometer PT6KV-254A	250KΩ	±20%	2.5mm*2.5
41338	PT6KV-504A2020	PIHER	Carbon Potentiometer PT6KV-504A	250KΩ	±20%	2.5mm*2.5



T E L : Taiwan: 886-3-5753170  
 F A X : Taiwan: 886-3-5753172  
 E-mail : Taiwan: [us\\_sale@100y.com.tw](mailto:us_sale@100y.com.tw)

Shenzhen: 86-755-83298787  
 Shenzhen: 86-755-83640655  
 Shenzhen: 100y@163.com

Shanghai: 86-21-54151736  
 Shanghai: 86-21-64605107  
 Shanghai: 100y-1@163.com