

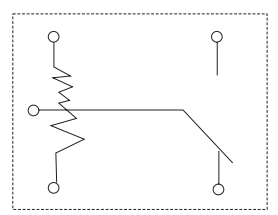

Relays & Solenoids

DIP PCB Reed Relays

Detailed product specifications are available on: us.100y.com.tw

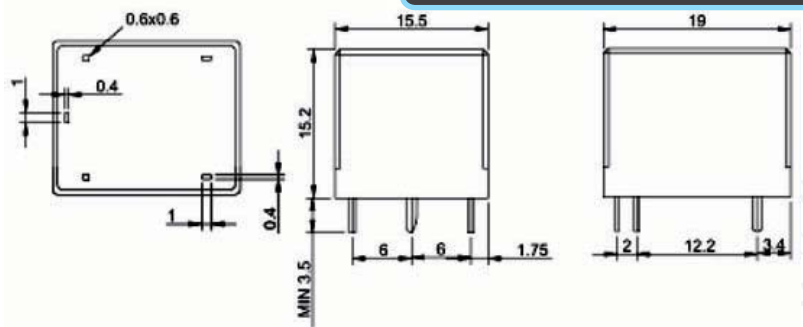

WIRING DIAGRAM
Bottom view

Part No.	Product No.	Manufacturer	Description	Carry current (A)	Coil Volt.	Safe criterion
47027	BS-115C-12A-12VDC	Bestar	Bestar_BS-115C Sub-Miniature Relay	12A	12V	UL/CSA/TUV

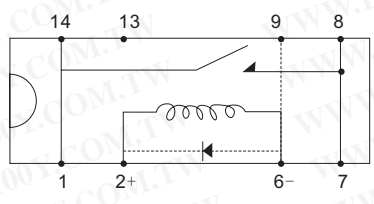
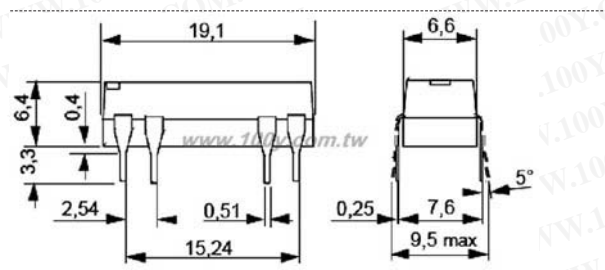

Part No.	Product No.	Manufacturer	Description	L*W*H(mm)	Contact Type	Carry current (A)	Coil Volt.
17706	D31A3110	Celduc	DIP PCB Reed Relays COIL:5Vdc	19.1*6.6*6.4	1N0	0.5A	5VDC
17708	D31A5110	Celduc	DIP PCB Reed Relays COIL:12Vdc	19.1*6.6*6.4	1N0	0.5A	12VDC
17709	D31A7110	Celduc	DIP PCB Reed Relays COIL:24Vdc	19.1*6.6*6.4	1N0	0.5A	24VDC
17710	D31C2110	Celduc	DIP PCB Reed Relays COIL:5Vdc	19.1*6.6*6.4	Change-over switch	0.25A	5VDC
17711	D31C5110	Celduc	DIP PCB Reed Relays COIL:12Vdc	19.1*6.6*6.4	Change-over switch	0.25A	12VDC

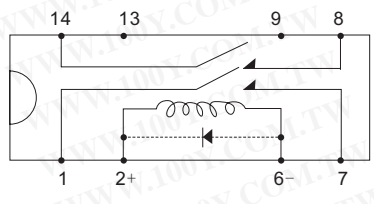
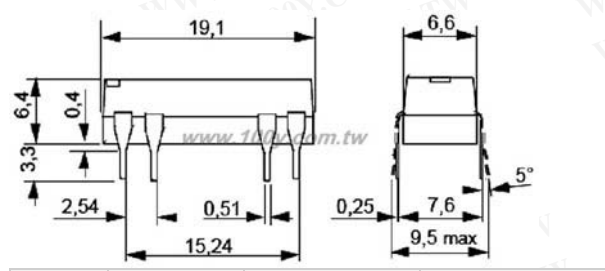

Part No.	Product No.	Manufacturer	Description	L*W*H(mm)	Contact Type	Carry current (A)	Coil Volt.
17712	D32A2110	Celduc	DIP PCB Reed Relays COIL:5Vdc	19.1*6.6*6.4	2NO	0.5A	5VDC



- Industry standard package
- Transfer molded for environmental protection
- Miniature size
- Compatible with DIP handling, sorting and PCB insertion equipment
- Optional shielding and diodes
- UL models available

Power (W) max. : 10
 Voltage (VDC) max. : 200
 Switching current (A) max. : 0.5
 Carry current (A) max. : 1.0
 Operate time (mS) max (incl. bounce) : 1.0
 Release time (mS) max : 0.5
 Electrical life: Low level: 10⁸ (10mVDC, 10µA)
 Rated load: 6x10⁵ (20VDC, 0.5A)

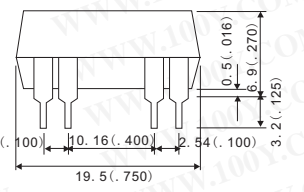
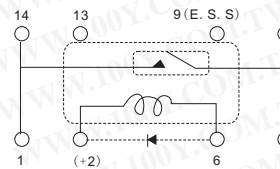
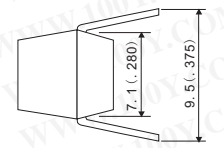
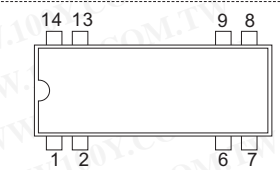

Part No.	Product No.	Description	Carry current (A)	Coil Volt.
42839	DA1A24DW	REED RELAYS	1.0	24V

• If you cannot find the components you want on the catalogue, please call us.

Taiwan: 886-3-5753170

Shanghai: 021-54151736 Shenzhen: 0755-83298787

Centenary Materials

Waiting for your phone call



T E L : Taiwan: 886-3-5753170
 F A X : Taiwan: 886-3-5753172
 E-mail : Taiwan: us_sale@100y.com.tw

Shenzhen: 86-755-83298787
 Shenzhen: 86-755-83640655
 Shenzhen: 100y@163.com

Shanghai: 86-21-54151736
 Shanghai: 86-21-64605107
 Shanghai: 100y-1@163.com